

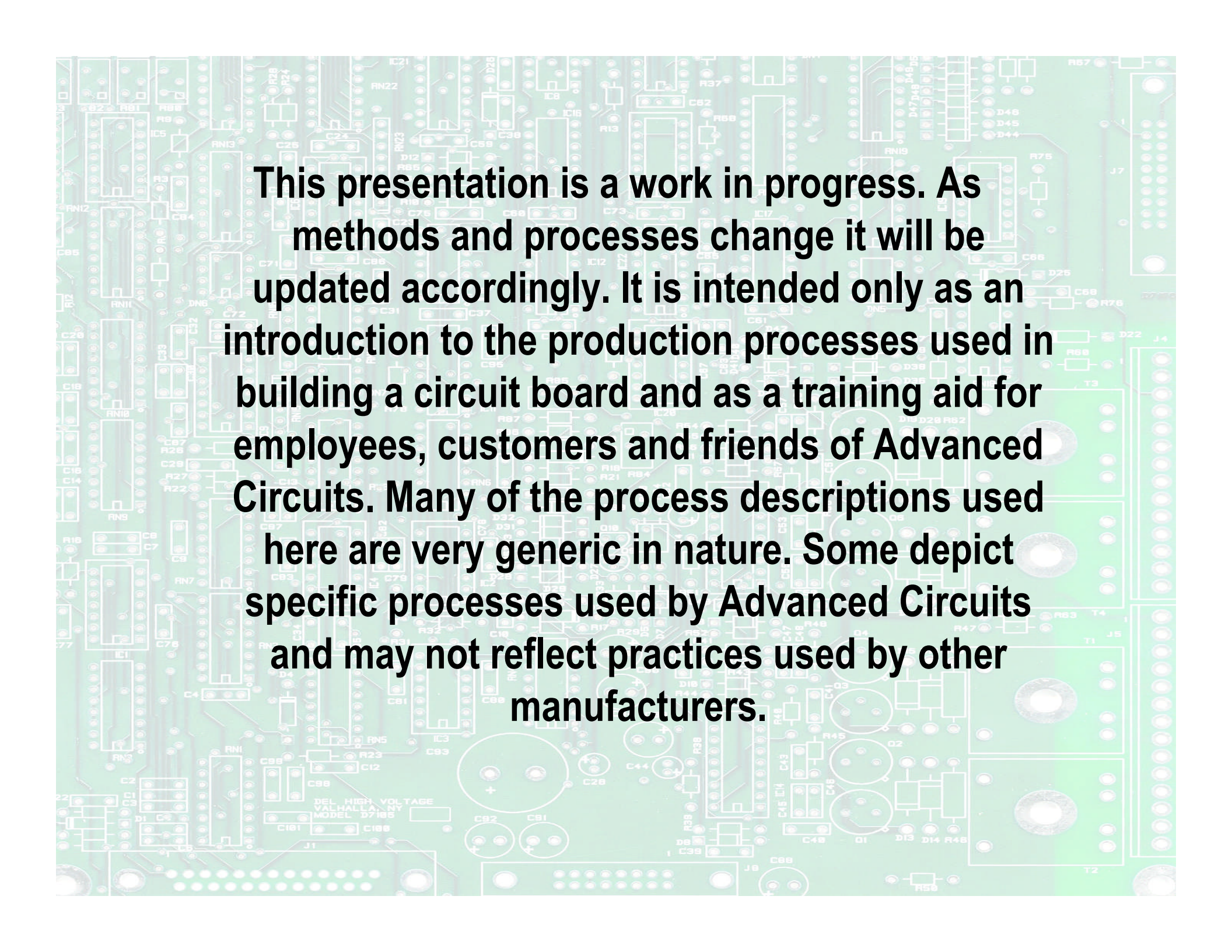

**ADVANCED
CIRCUITS**

#1 In Quickturn Printed Circuit Boards

How to Build a Printed Circuit Board



This presentation is a work in progress. As methods and processes change it will be updated accordingly. It is intended only as an introduction to the production processes used in building a circuit board and as a training aid for employees, customers and friends of Advanced Circuits. Many of the process descriptions used here are very generic in nature. Some depict specific processes used by Advanced Circuits and may not reflect practices used by other manufacturers.

Single & Double Sided Circuit Boards

A single sided board is made from rigid laminate consisting of a woven glass epoxy base material clad with **copper on one side** of varying thickness.

Double sided boards are made from the same type of base material clad with **copper on two sides** of varying thickness.

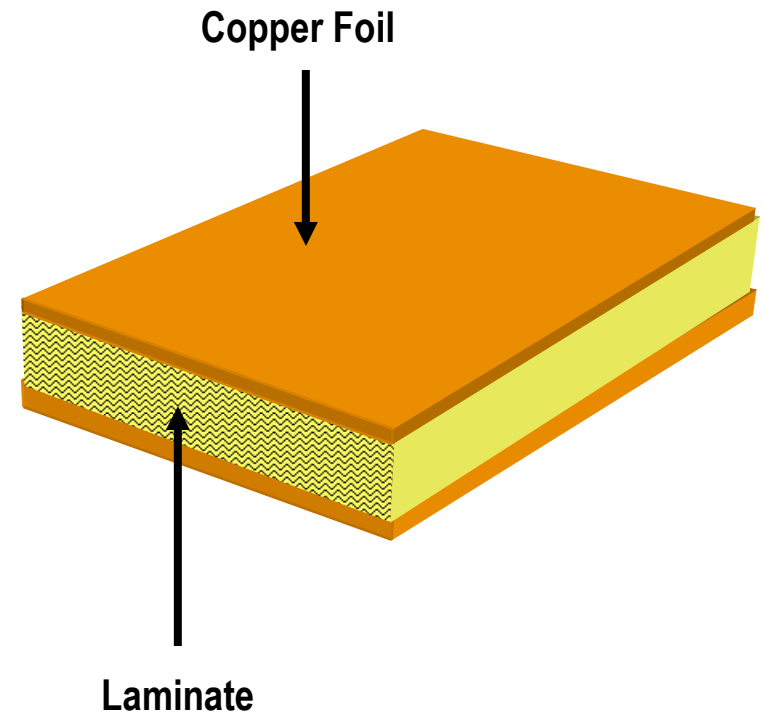

Multi-Layer Board

Multi-layer boards are made from the same base material with copper foil on the top & bottom and one or more “inner layer” cores. The number of “layers” corresponds to the number of copper foil layers.

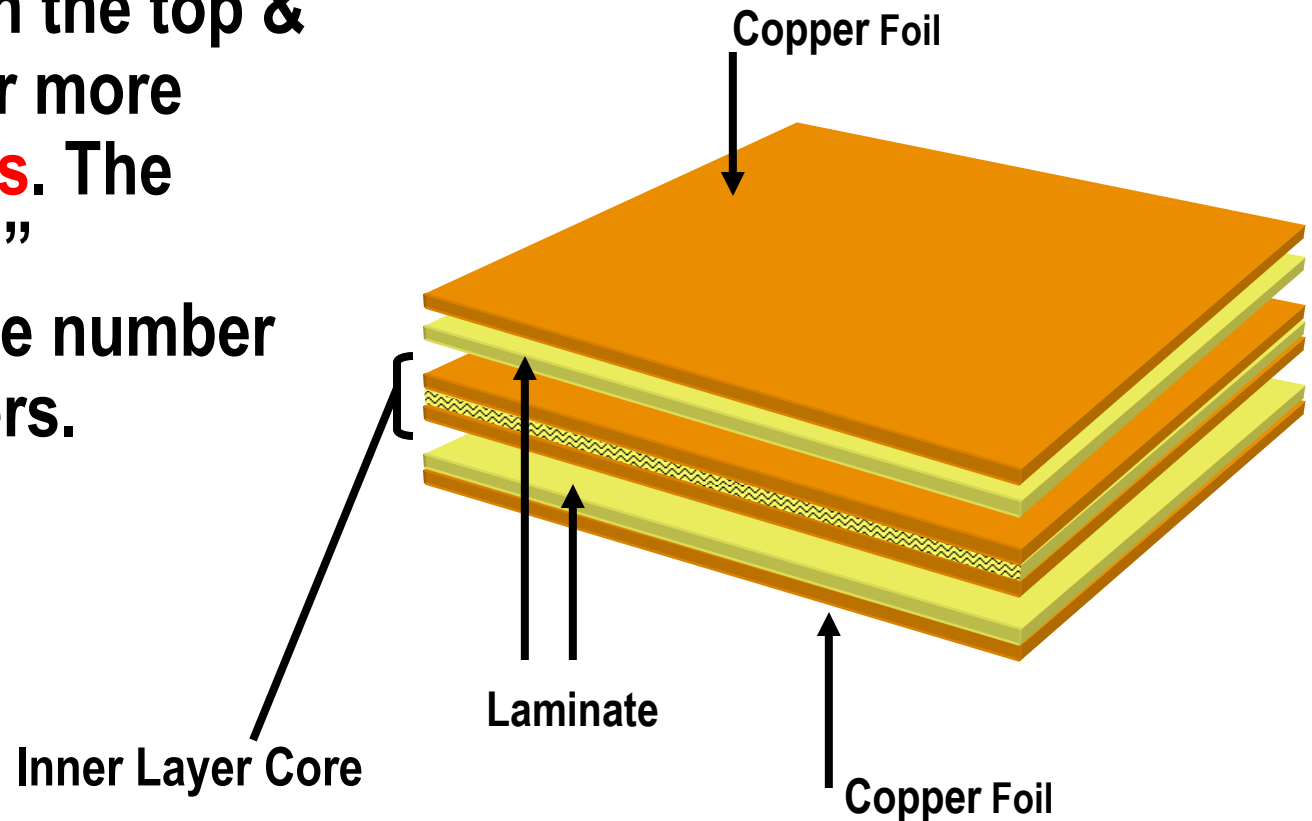

Multi-Layer Board Fabrication

Multi-layer fabrication begins with the selection of an inner layer core – or thin laminate material of the proper thickness. Cores can vary from 0.038” to 0.005” thick and the number of cores used will depend upon the board’s design.

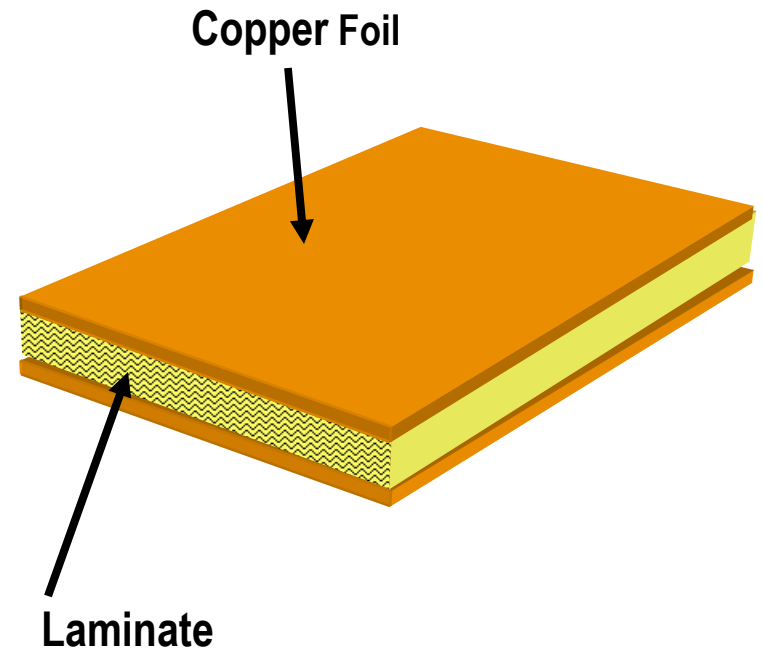

Dry-film Resist Coating

Inner Layer Core Material

A light sensitive film or photo image-able “resist” is then applied by heat and pressure to the metal surfaces of the core. The film is sensitive to ultraviolet light. You will find “yellow light” used in most Image processing areas to prevent inadvertent exposure of the resist. The filters remove the wave length of light that would affect the resist coating.

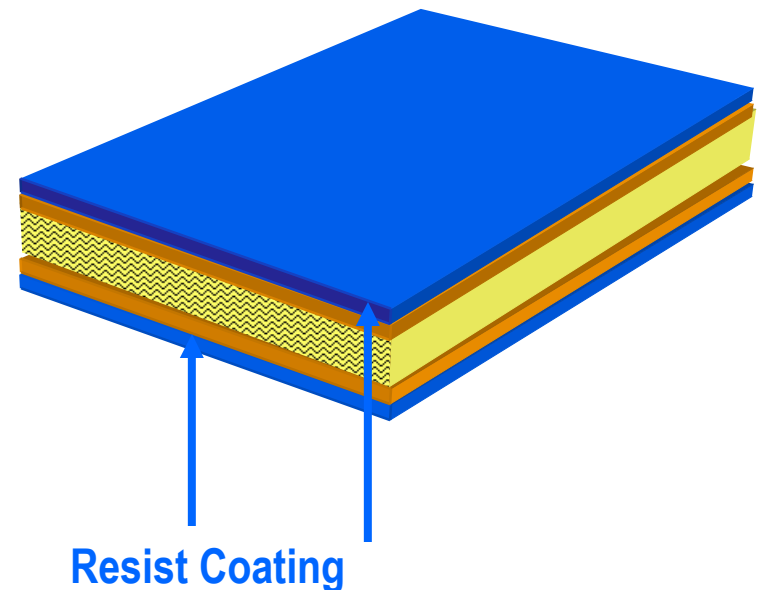
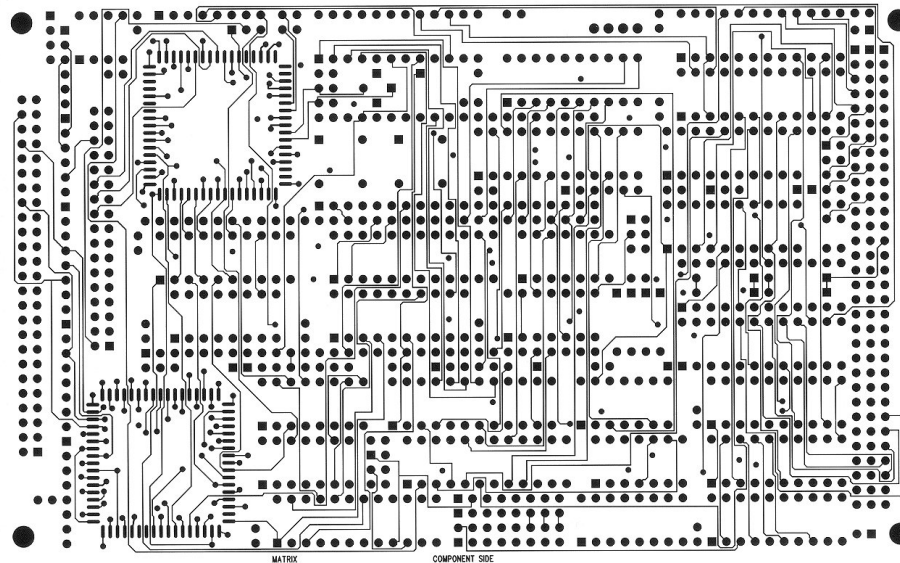
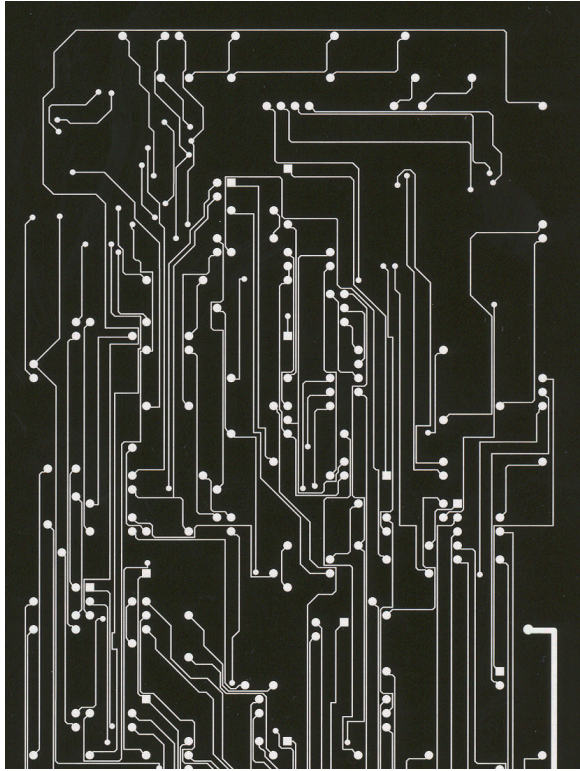

Photo Tools or Artwork

The gerber data or electronic data for the part is used to plot film that depicts the traces and pads of the board's design. The photo tools or artwork include solder mask and legend or nomenclature as well as the copper features. This film is used to place an image on the resist.





Internal Signal Layer

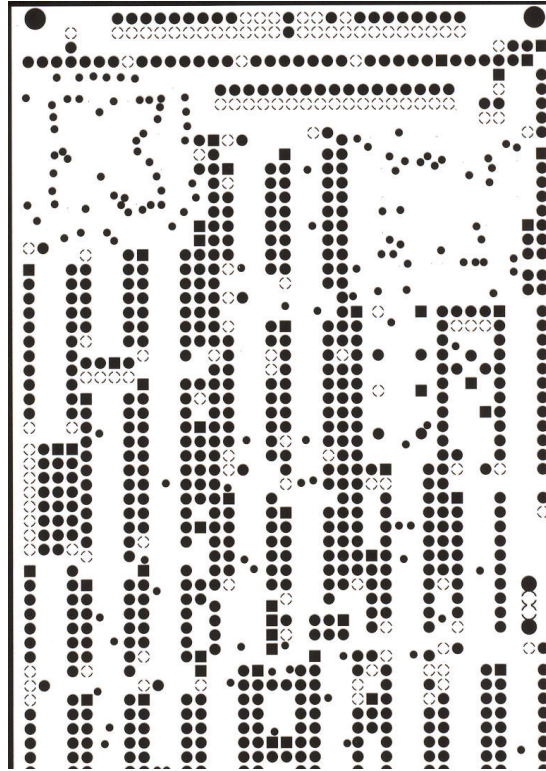

Internal Ground Layer

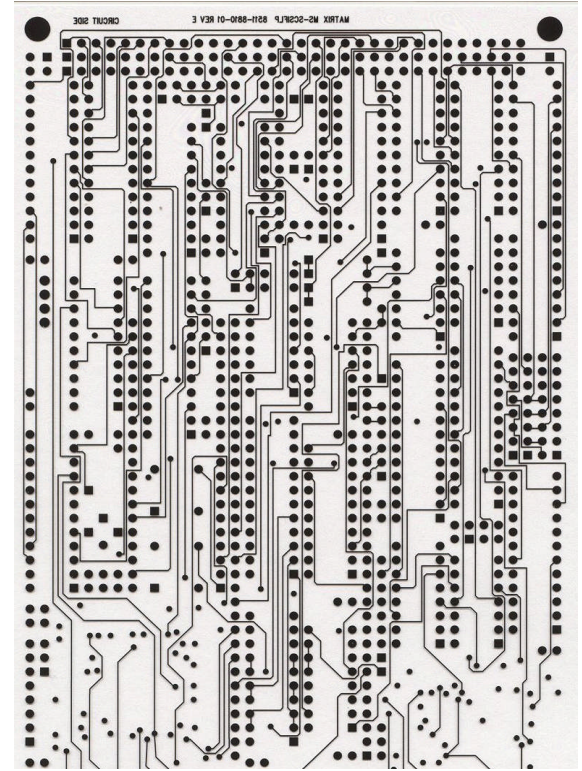

External Signal Layer

Each of the circuit and land patterns are unique to that part number and each layer has its own artwork pattern or piece of film. Inner layer film is negative and outer layer film is positive.

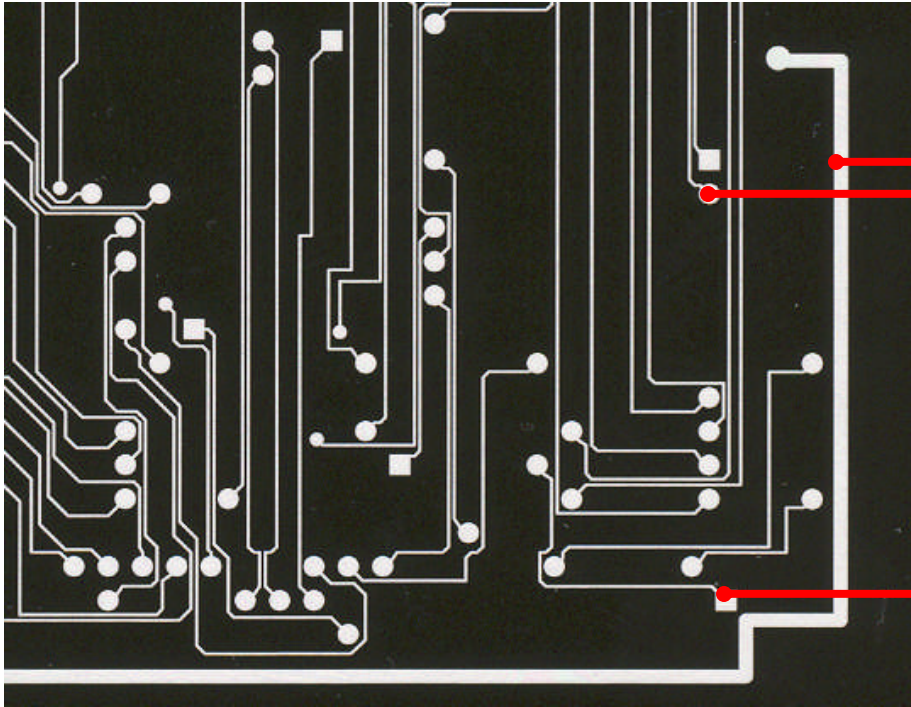

Inner layer film is “negative”. That means that the copper patterns left behind after processing the core are the “clear” areas on the film.

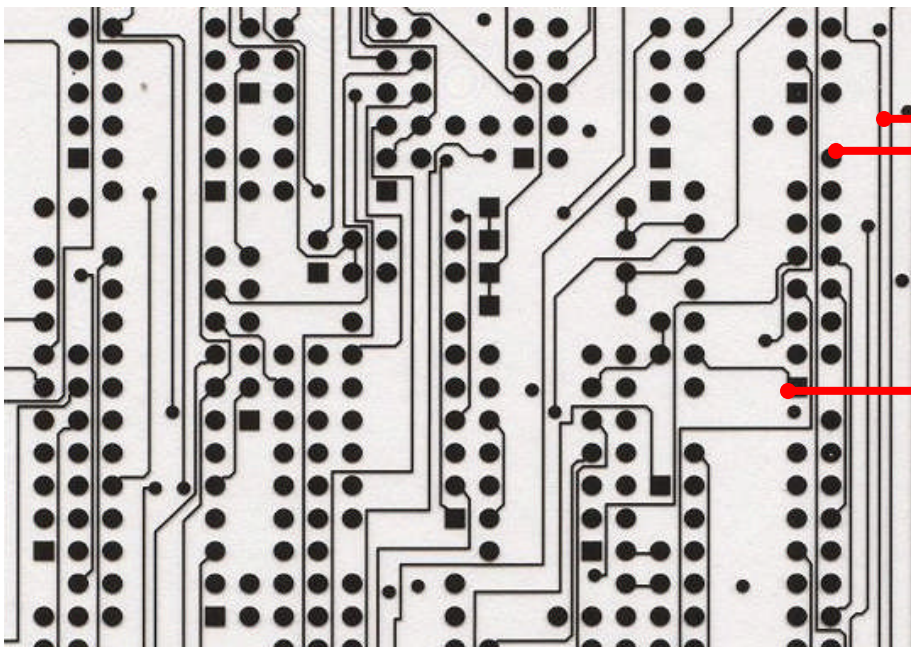

Outer layer film is “positive”. The traces and pads that are “opaque” on the film are copper on the outside of the board and the clear areas will be clear of copper.

Image Expose

Panels are then exposed to a high intensity ultraviolet light source coming through the film. Clear areas allow light to pass through and polymerize (harden) the film resist thus creating an image of the circuit pattern – similar to a negative and a photograph.

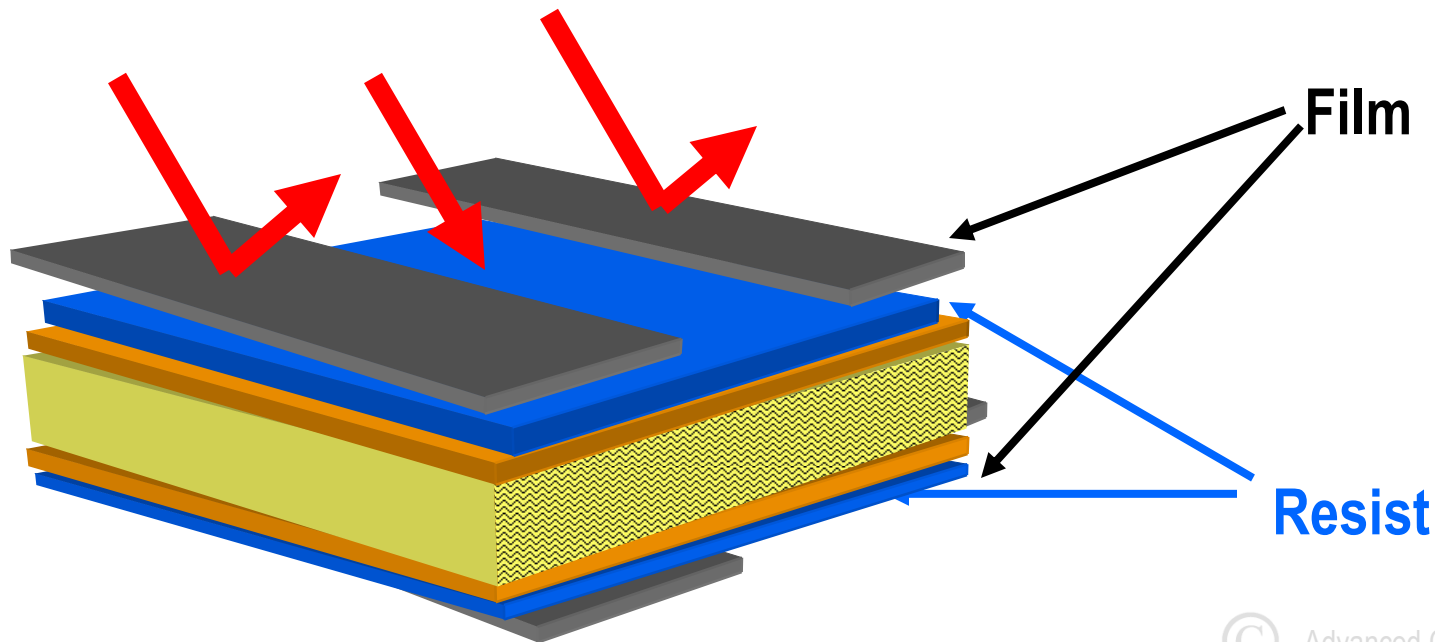
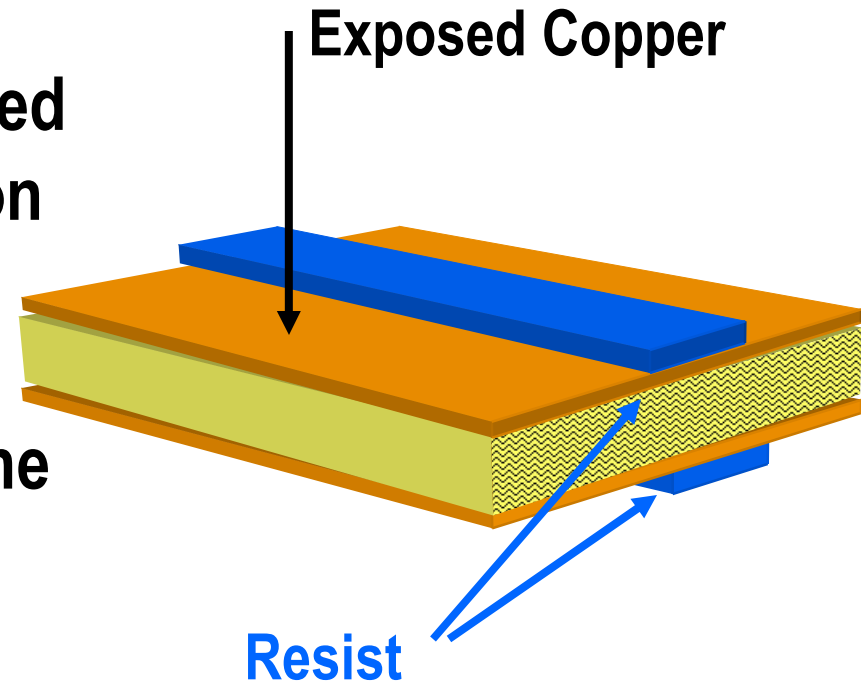
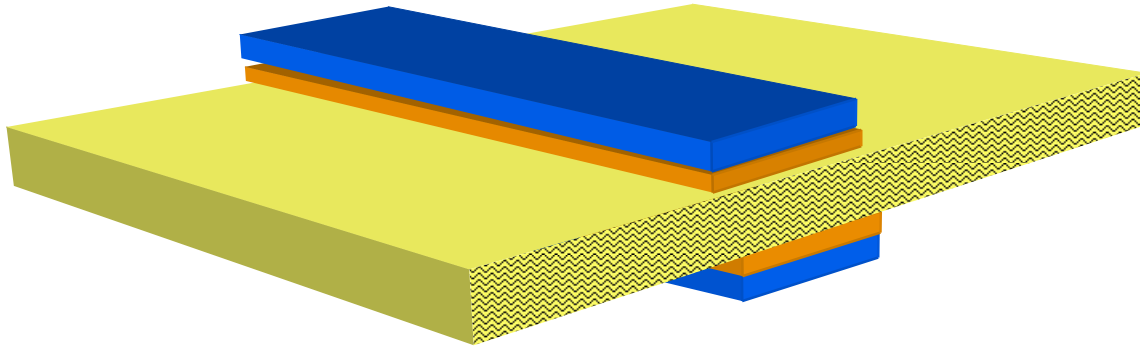

Image Develop

The exposed core is processed through a chemical solution or developer that removes the resist from areas that were not polymerized by the light.



Inner Layer Etch



Then the copper is chemically removed from the core in all areas not covered by the dry-film resist. This creates the copper pattern that matches the film pattern. The core laminate surface is exposed in areas where copper was etched away.

Resist Strip

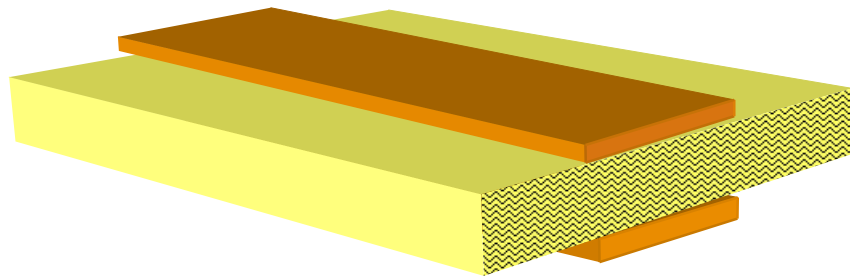

After etch, the developed dry-film resist is chemically removed from the panel leaving the copper on the panel. Traces, pads, ground plane and other design features are now exposed.

Automated Optical Inspection or AOI

Inner layers are then inspected against design rules using data from the gerber files.

If allowed and practical, some repairs can be made at this point. Information on defects is shared with the appropriate departments to correct any process problems.

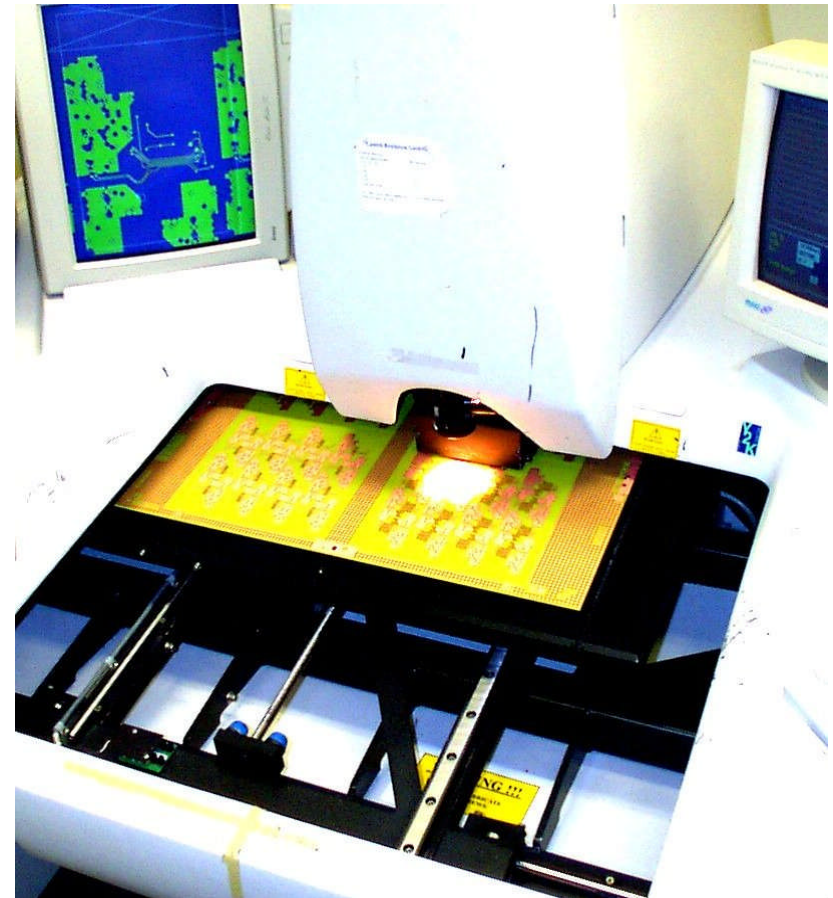

Oxide Coating

After inspection the panels are chemically treated to improve adhesion of the copper surface. Advanced Circuits uses organic chemistry that leaves the copper a dark brown. Other types of chemistry or mechanical methods can be used and colors vary widely.

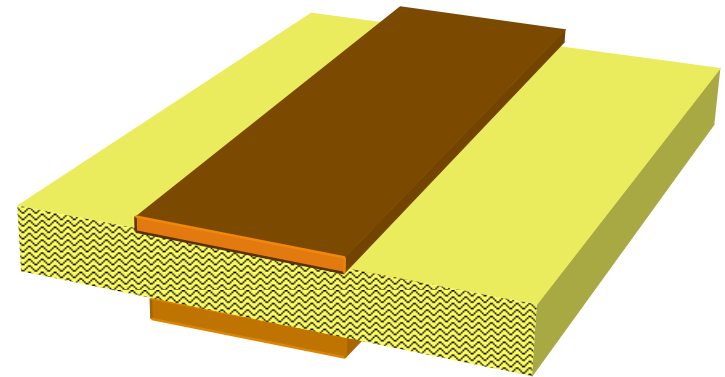

Multi-Layer Construction

The basic materials needed to build a multi-layer board are copper foil, prepreg and inner-layer cores.

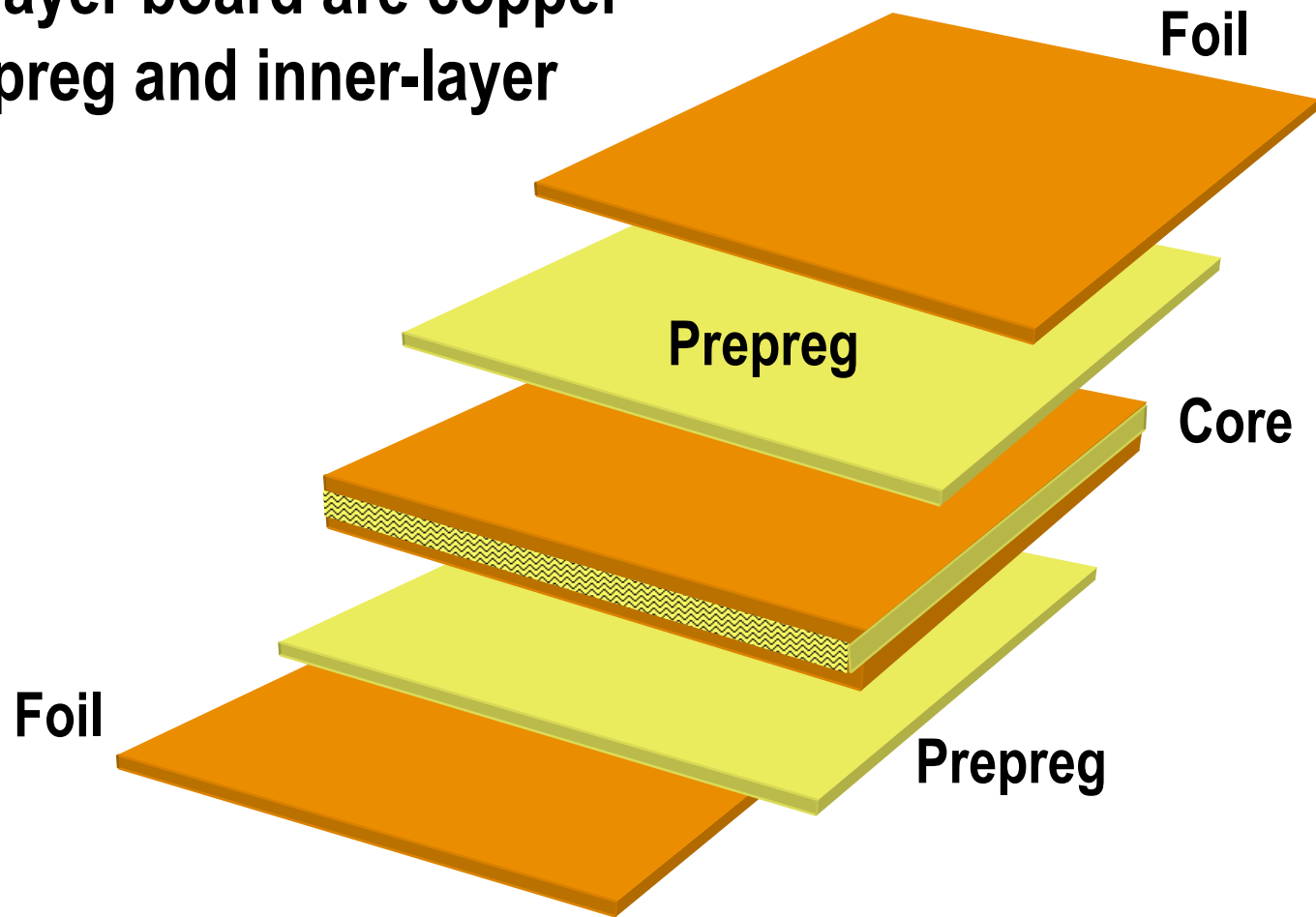

Copper Foil

The copper foil used in circuit boards is typically in sheets of $\frac{1}{2}$ oz. and 1 oz. per square foot in **weight** or 0.0007 and 0.00134 inches nominal **thickness**. In other words - one ounce of copper will cover one square foot when it is rolled out to a thickness of 0.00134" or 1.34 mils.

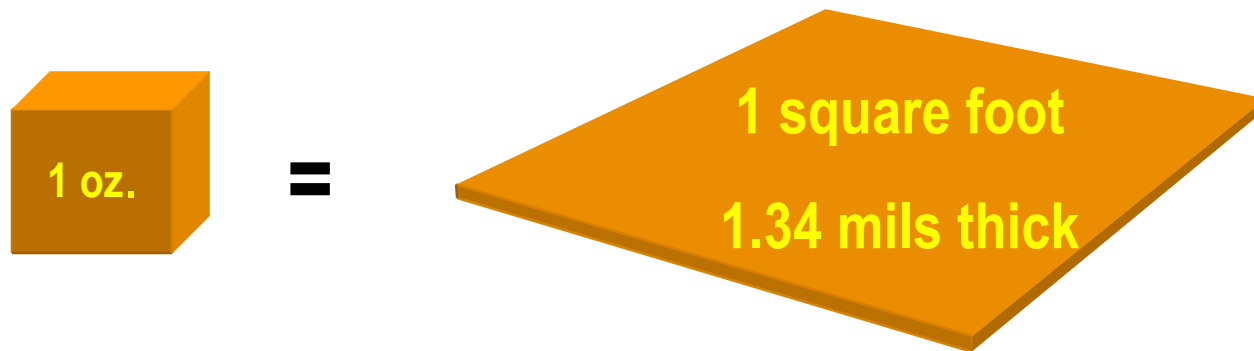

PrePreg or Preimpregnated Bonding Sheet

It's the “glue” that holds the cores together. There are many types of materials, we use FR4 – a woven fiberglass cloth pre-impregnated with epoxy resin - known in the industry as B-stage.

The resin is activated and “melts” during the lamination process from pressure and heat. It flows across copper features and exposed laminate on the core and as it cools bonds the layers of foil and core together.

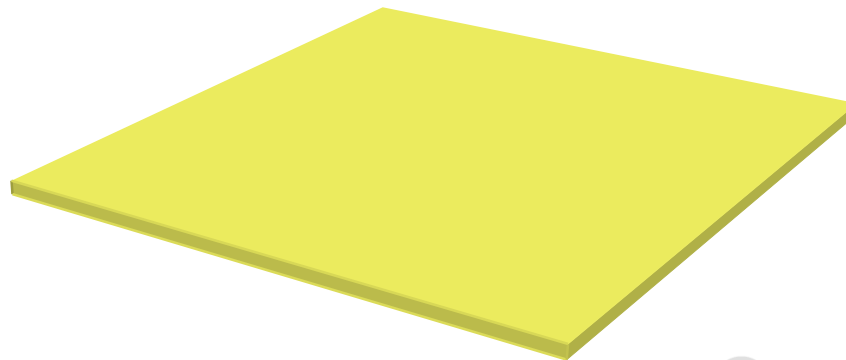

Laminated Panels

Inner layer core, copper foil and prepreg are bonded together under heat and pressure, sometimes in a vacuum, during the lamination process. The result is a panel with several layers of copper inside as well as the foil on the outside.

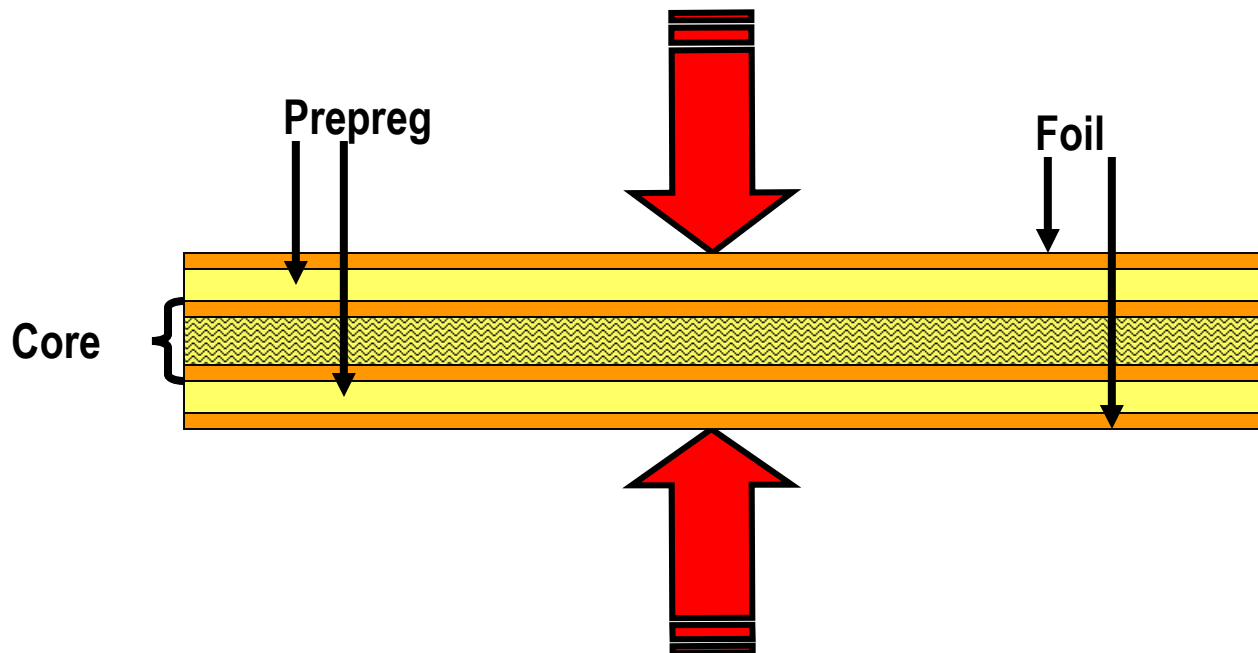

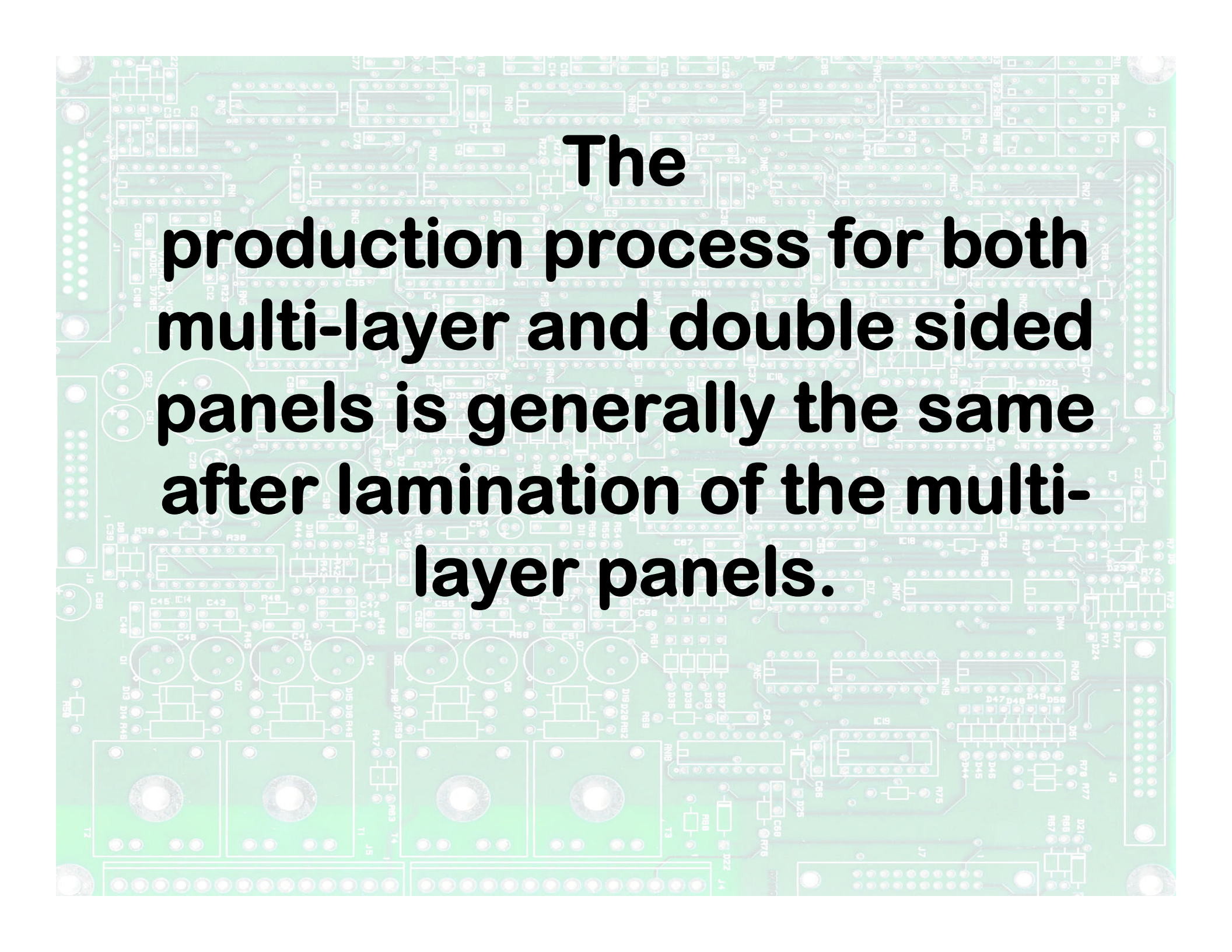

**The
production process for both
multi-layer and double sided
panels is generally the same
after lamination of the multi-
layer panels.**

Primary or First Drill

Holes of various sizes are drilled through a stack of panels (usually 2 to 3 high). The locations are determined by the board's designer to fit specific components. Drilled hole sizes are usually 5 mils larger than finished plated through hole sizes to allow for the copper plating process.

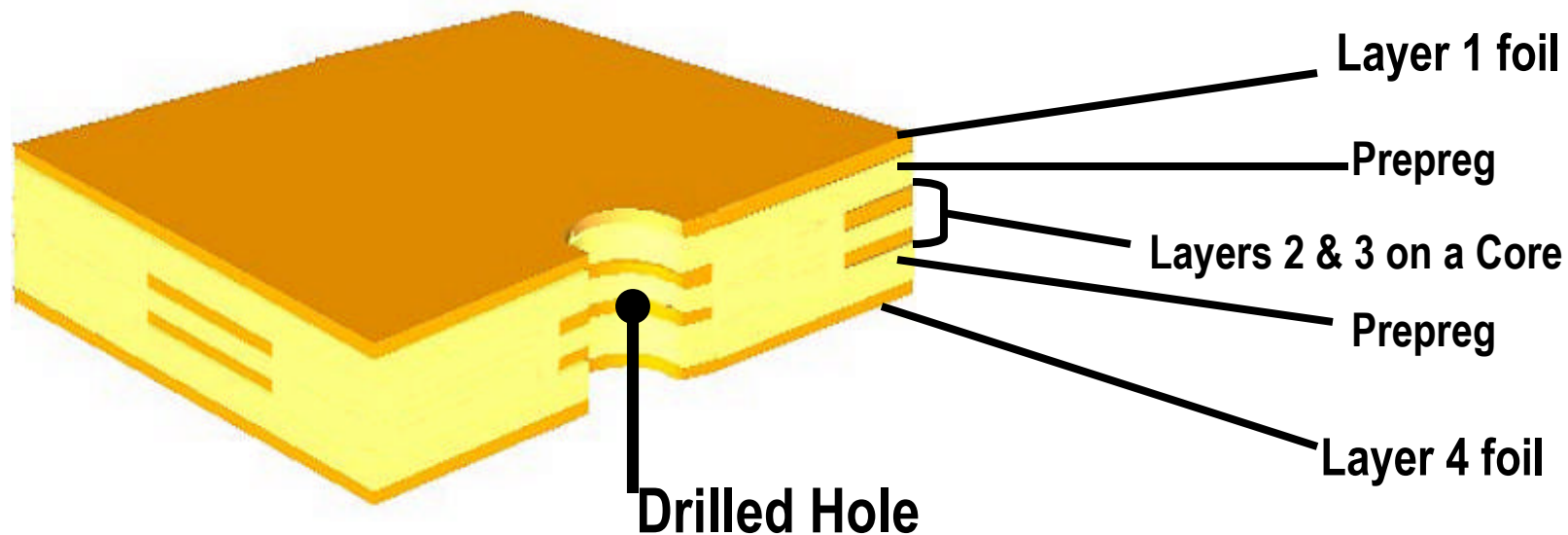

Deburr

Deburr is an abrasive mechanical process that removes the raised edges of the metal or burrs surrounding the holes that occur during the drilling process. Any debris that may be left in the holes is also removed at this time.

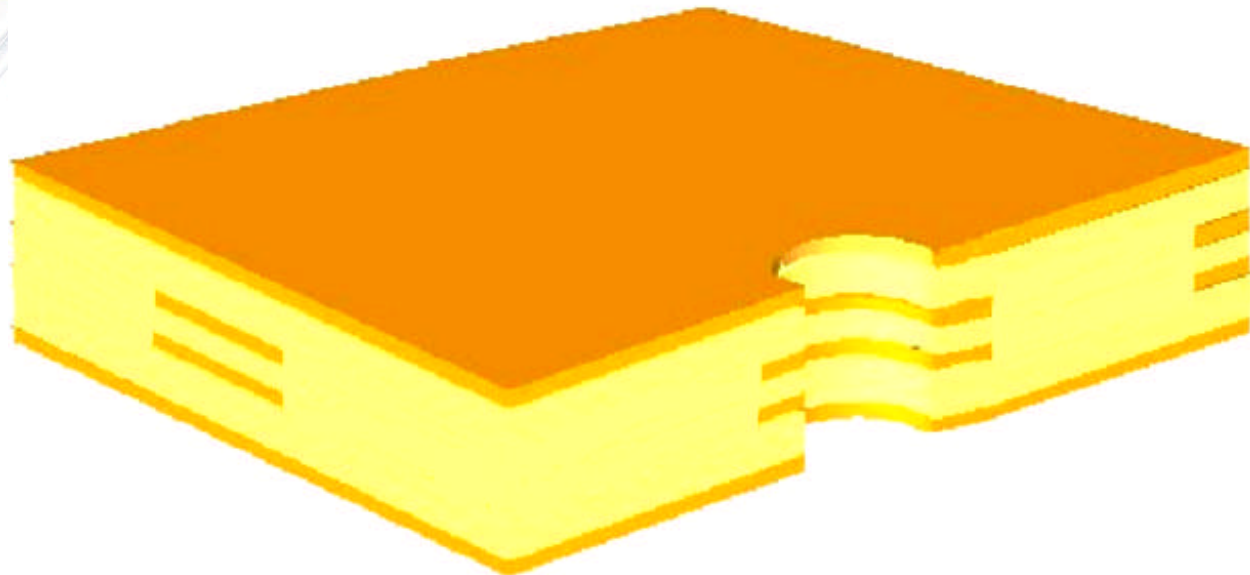

Desmear - Multi-layer Boards Only

Desmear generally applies
only to multilayer boards.

It is a chemical process that
removes the thin coating of
resin from the inner layer
connections that is
produced by the heat and
motion of the drill bits as
they create the holes.

Removing the resin smear
improves the electrical
connectivity.

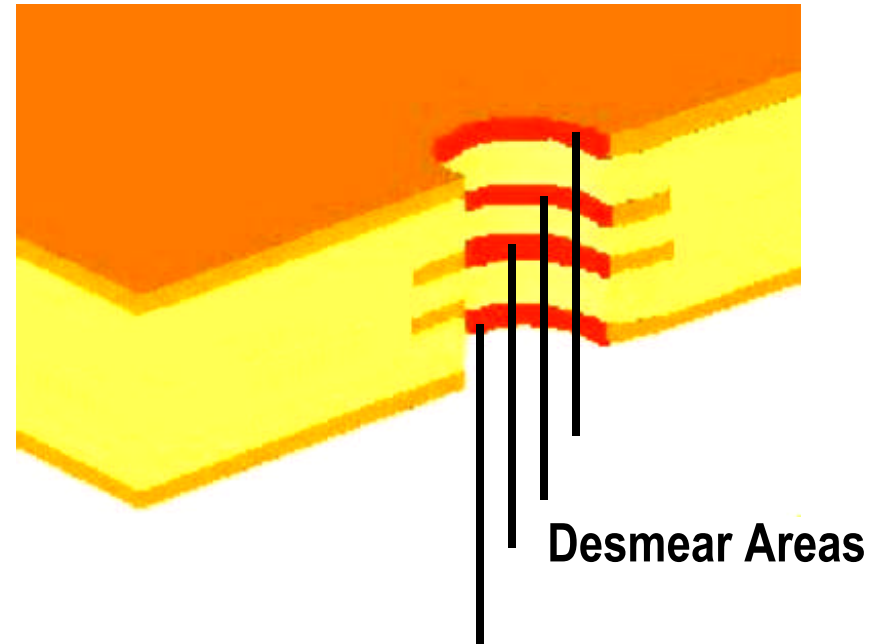

Electroless Copper Deposition

Once the smear is removed, a thin coating of copper is chemically deposited on all of the exposed surfaces of the panel, including the hole walls. This creates a metallic base for electroplating copper into the holes and onto the surface. The thickness of the electroless deposit is between 45 & 60 millionths of an inch.

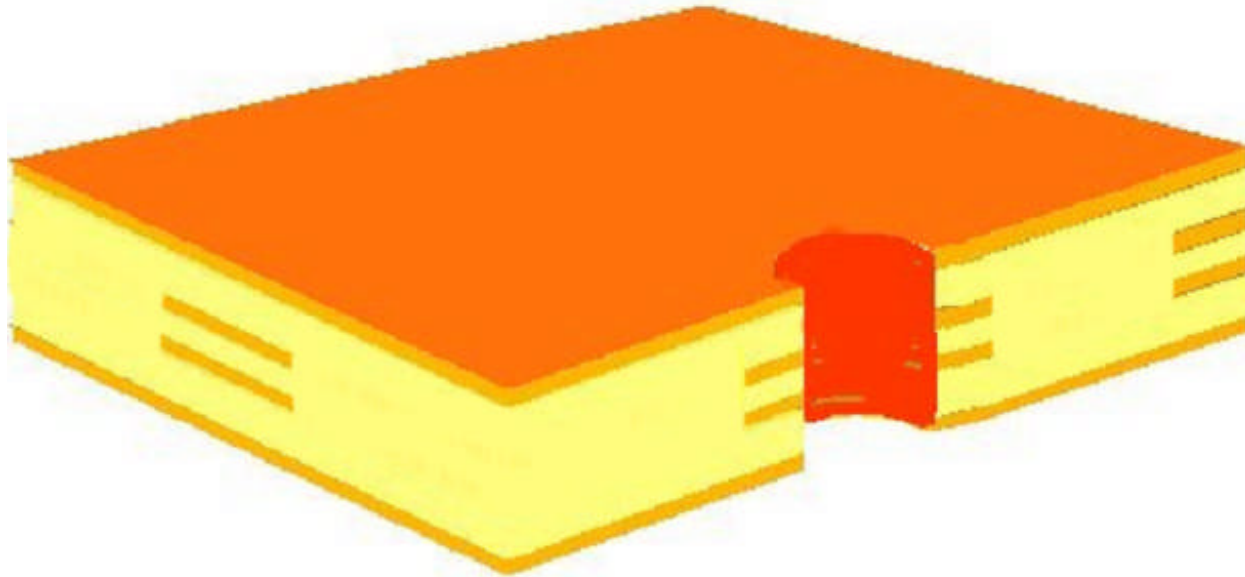

Dry-film Resist Coating Outer Layer Panels

The same resist or light sensitive film used on the inner layers is used for the outer layers. The film covers the entire surface including the drilled holes.

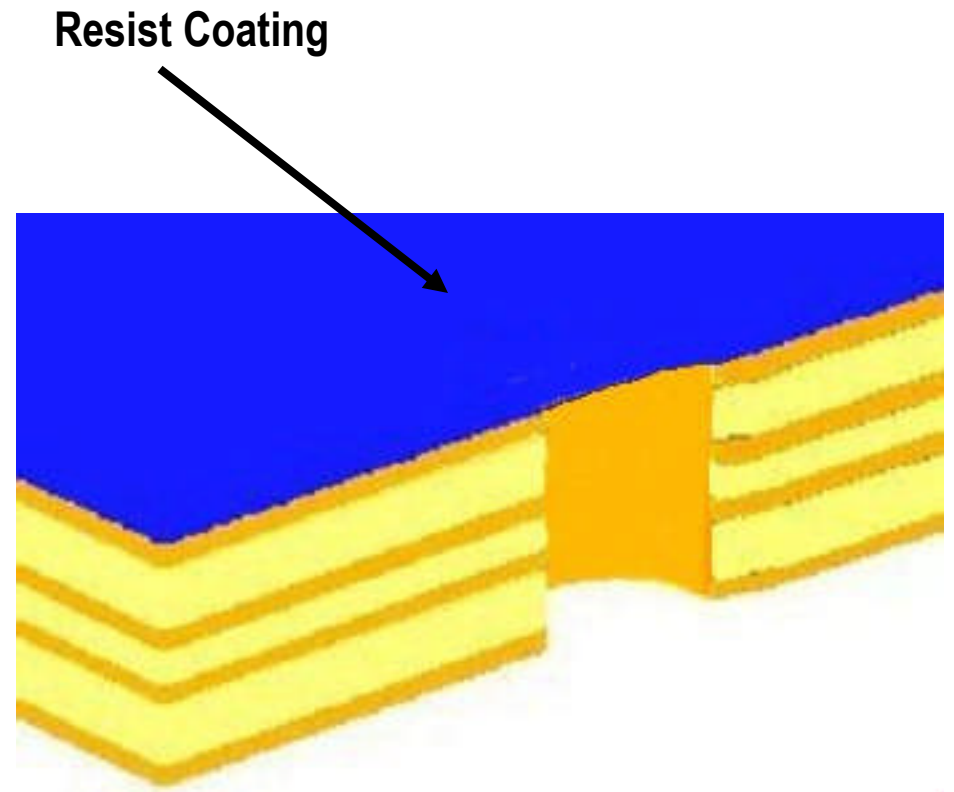

Outer Layer Expose & Develop

After dry film lamination the panel is exposed and developed using the same procedure used for the inner layer cores. Clear areas in the film allow light to pass through and harden the resist creating an image of the circuit pattern. All of the drilled holes that are exposed will be plated through.

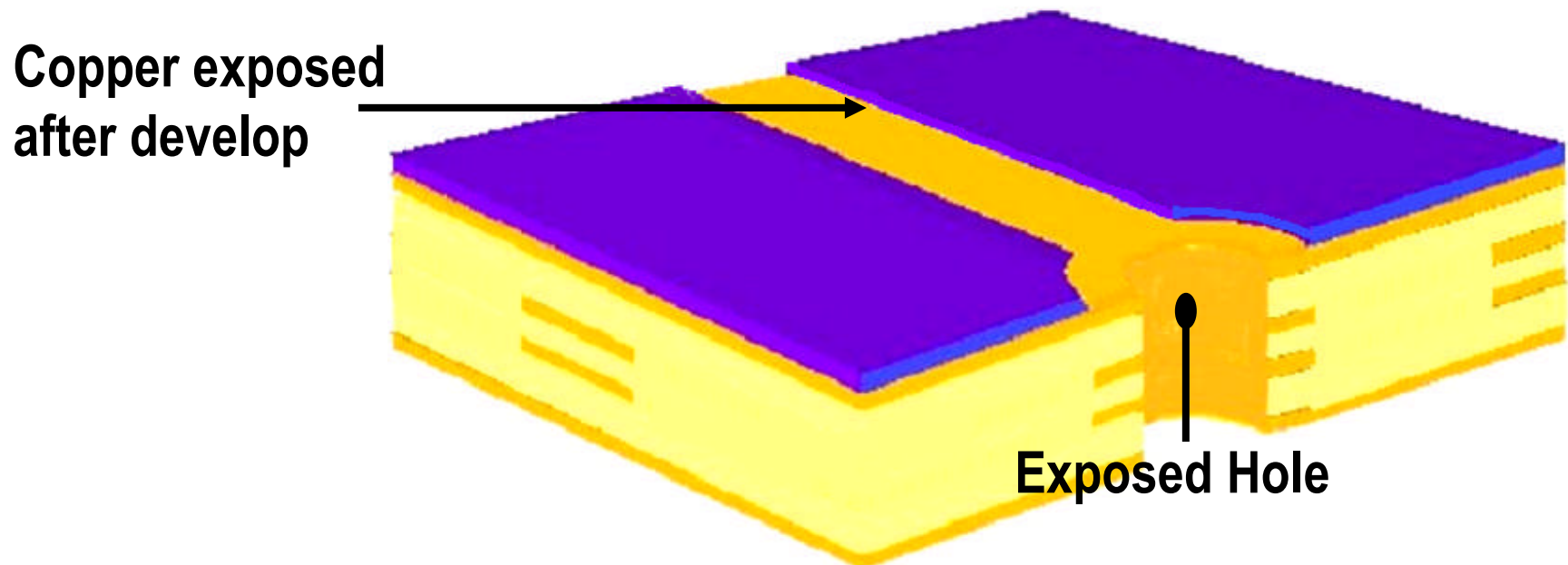

Copper “Pattern” Plate

The electroplating processes that electrically plates copper onto the exposed metal surfaces is next. The copper will be plated up to a thickness of approximately 1 mil (0.001”), depending on the required final finish for the panel.

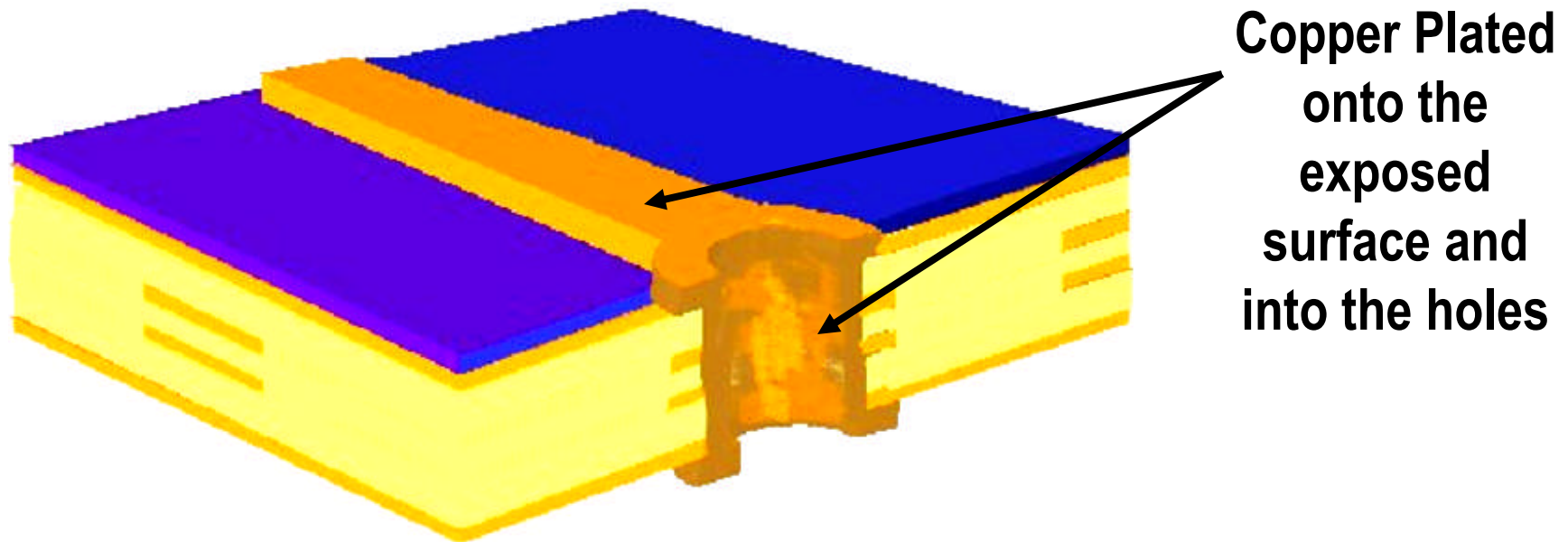

Tin Plating

The copper plating step is followed by plating tin onto all the exposed copper surfaces. The tin will be used as an etch resist to maintain the copper traces, hole pads and walls during the outer layer etch process.

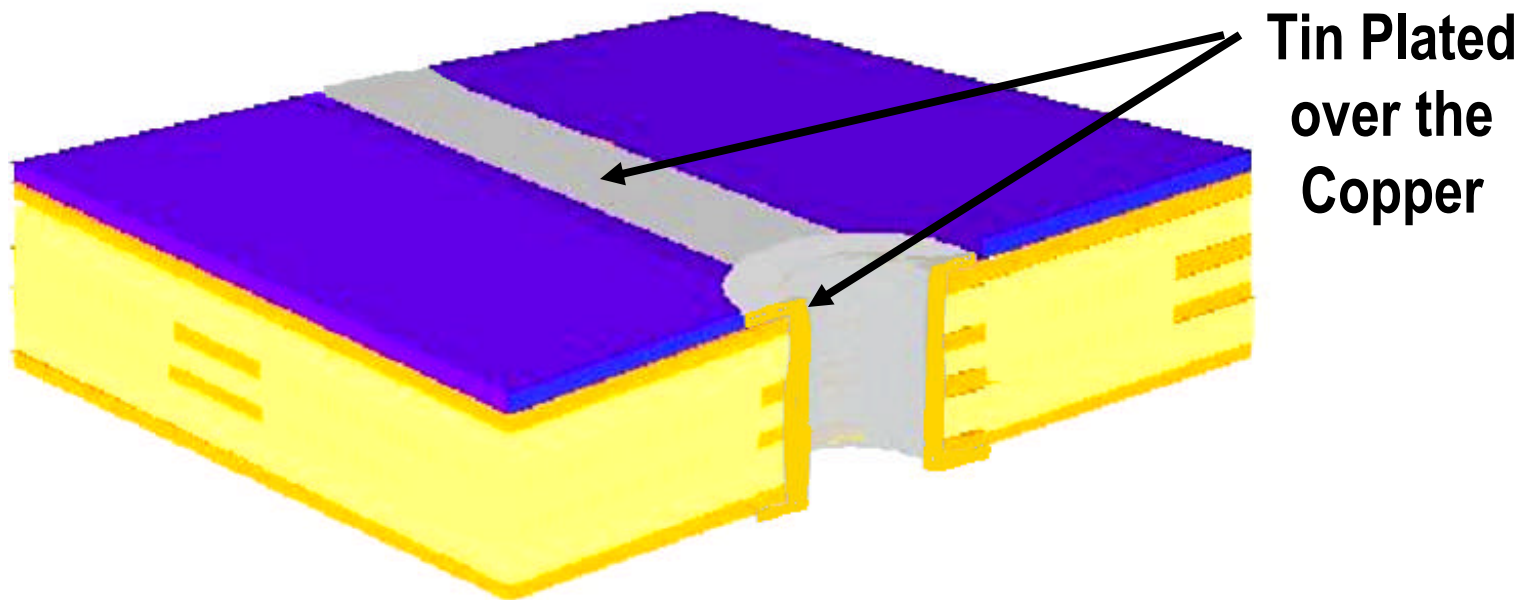

Resist Strip

The developed dry film resist is now removed from the panel. The tin plating is not affected. Any holes that were covered with resist are now open and will be non-plated. This is the first step in the common phrase “**strip**-etch-strip” or “**S**ES” process.

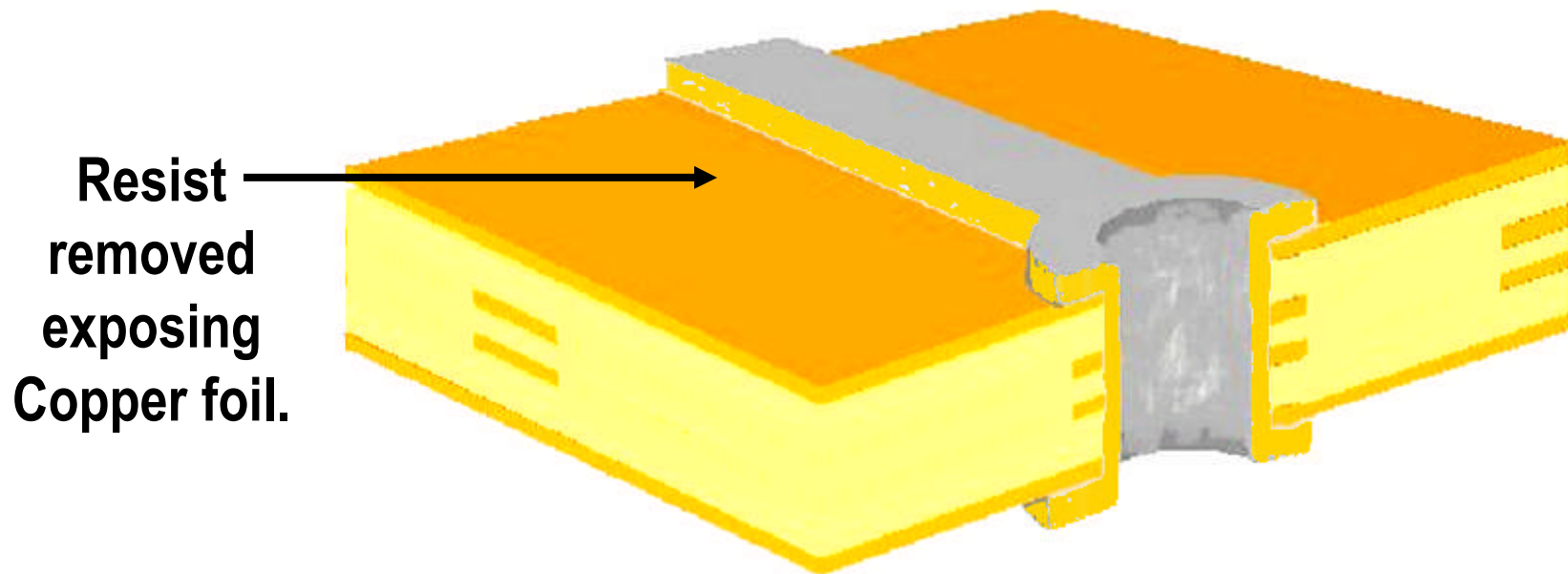

Etch

Copper is now removed from all parts of the panel that are not covered by tin. The tin resists the chemicals used to etch away the copper. Only the pads and traces from the artwork are left behind on the panel surface. The “E” of SES.

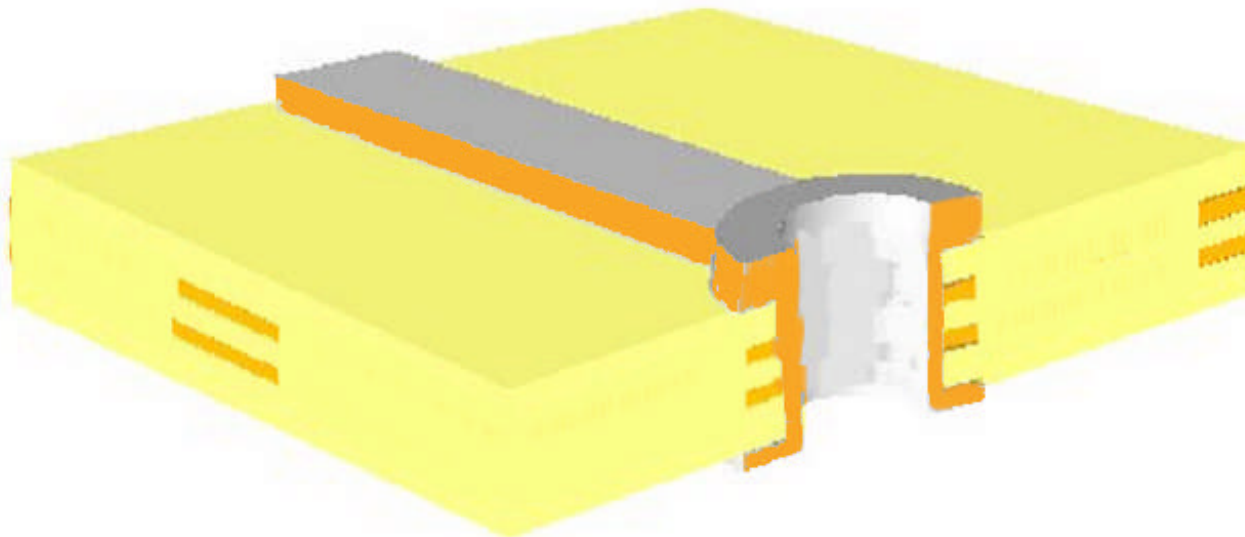

Tin Strip

Then the tin is chemically removed leaving behind a bare copper and laminate panel. The surface pads, traces and plated through holes are the exposed copper. This is the last step in strip-etch-**strip**.

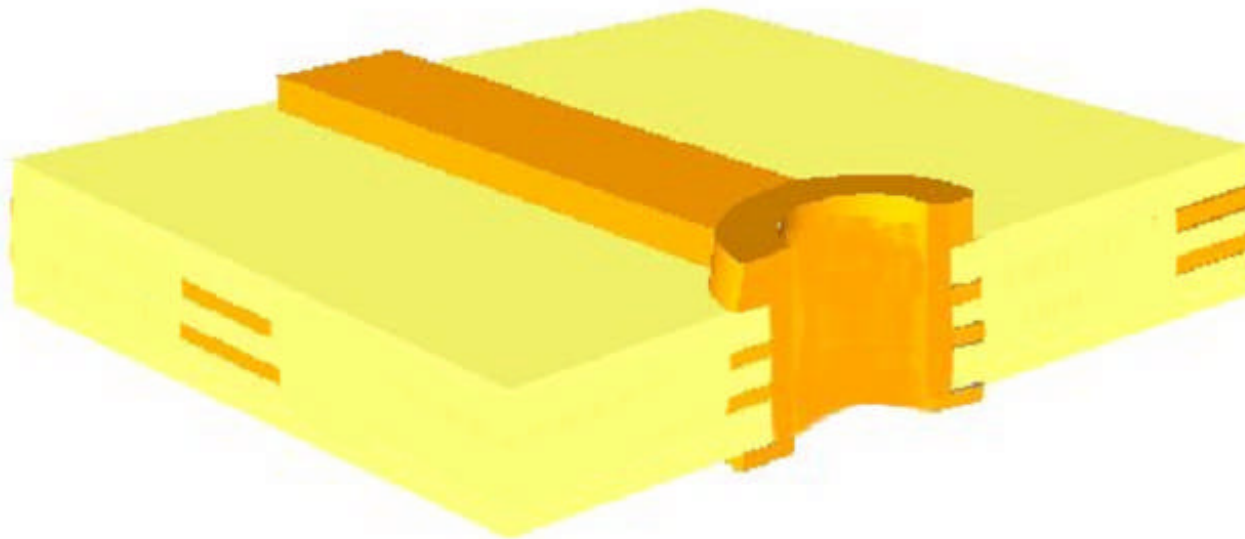

Clean and Prep for Solder Mask

The exposed copper surface pads, traces and plated through holes must be clean and free of oxidation prior to applying solder mask. During the cleaning process the surface is scrubbed with pumice to improve adhesion of the mask as well as to remove any surface contamination.

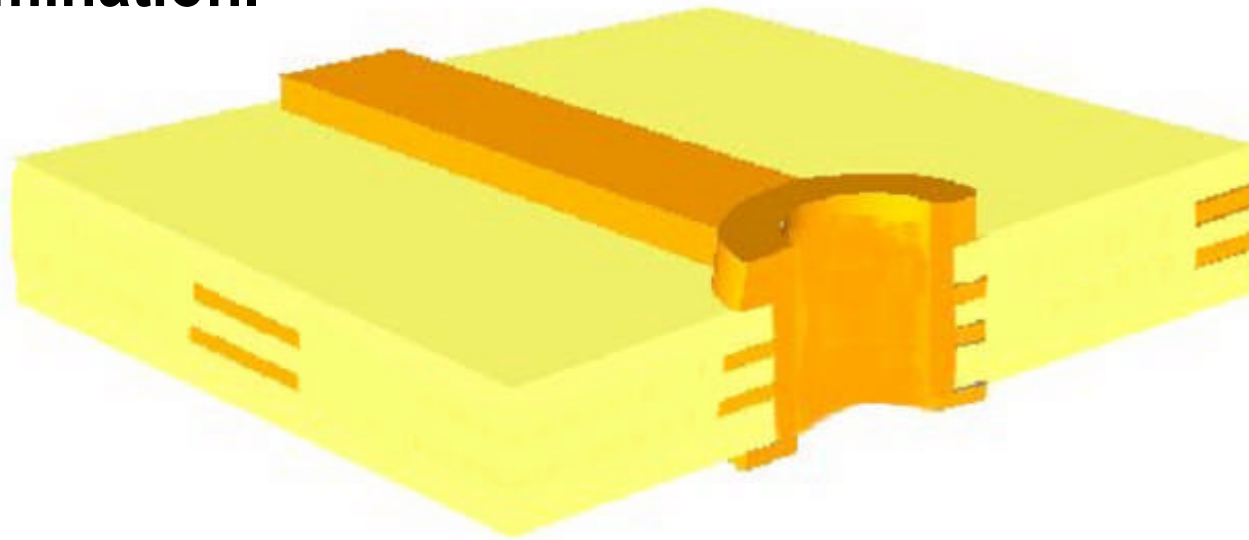

LPI Solder Mask Application

A photo-sensitive epoxy based ink is applied, completely coating the panel. It is then dried to the touch but not final cured. Using a method identical to image, the panels are exposed to a light source through a film tool. Then the panel is developed exposing the copper pads and hole defined by the artwork.

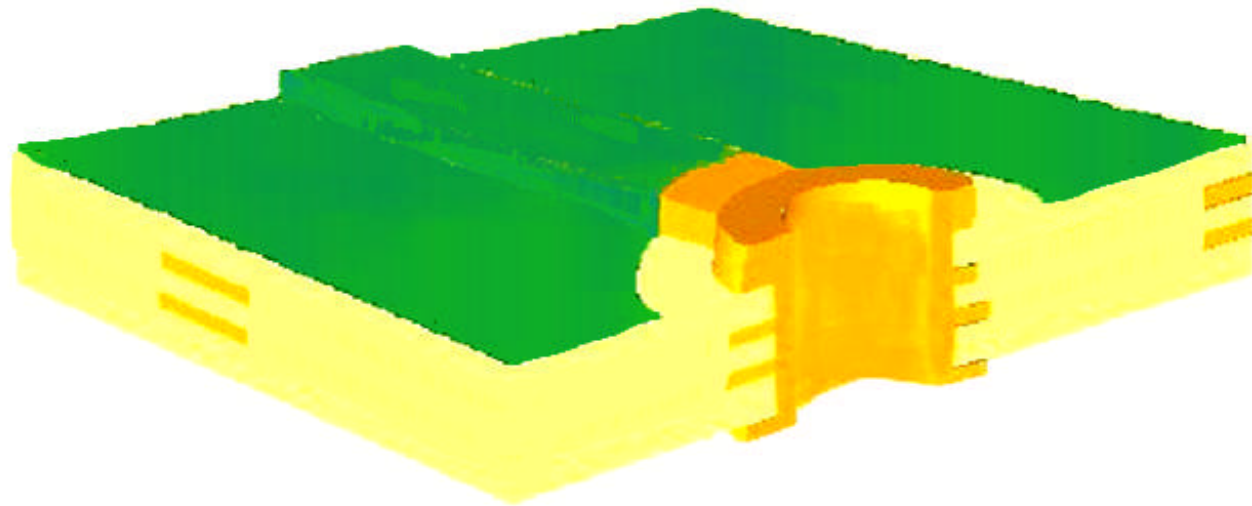

Solder Mask Cure

Solder mask is normally cured by baking in an oven; however, some fabricators are using infrared heat sources. The primary purpose of the mask is to restrict the areas that will be covered with solder. It also protects panels from contamination, handling damage and possible electrical shorting during assembly and installation.

At Advanced Circuits, whenever possible, legend or nomenclature would be screened on the panels before further processing. Also, at Advanced the nickel and gold plating for edge connectors occurs immediately after final cure of the solder mask and legend.

There are a number of processing options that can occur depending upon the desired final finish. Currently at Advanced Circuits we can provide our customers with a SnPb or lead free solder finish, hard gold, Electro less Nickel Immersion Gold (ENIG), immersion tin or immersion silver. Other finishes include Organic Solderable Preservative (OSP), soft or bondable gold and a number of other “exotic” finishes like palladium.

“Normal” processing would continue with the application of solder.

Legend, Silkscreen, Nomenclature, Component Designator

Ink is silkscreened onto one or both sides of the panel depending on the requirements of the customer. The printing usually dictates component placement, part number or name, date code, logo or other specified information. Panels are then baked to cure the ink.

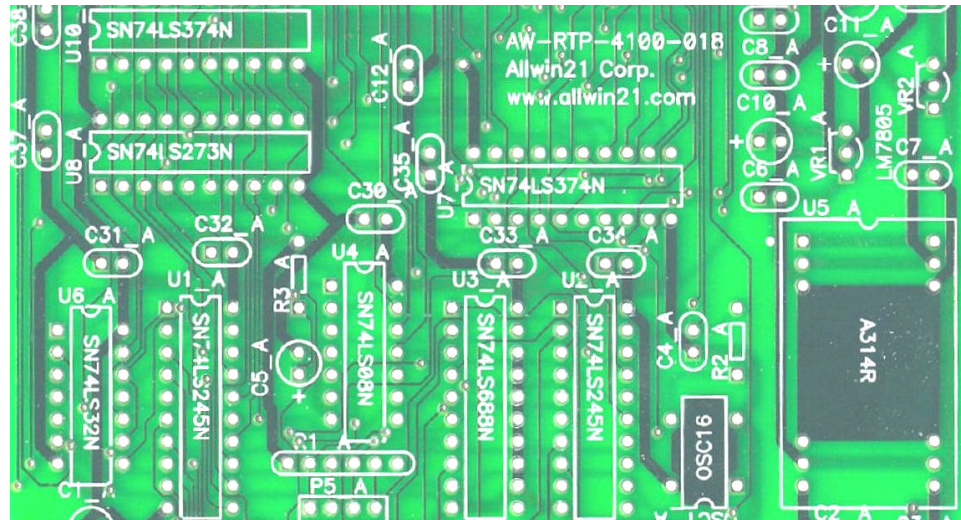

Hot Air Solder Leveling (HASL)

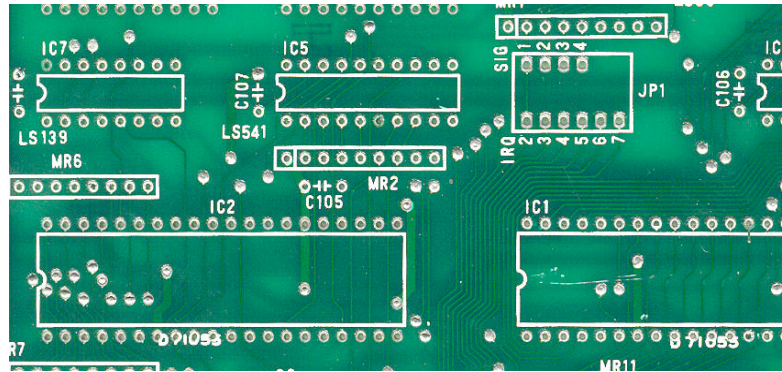

The panels are coated with flux – a viscous compound that promotes even coating of the copper. Then the panels are dipped completely into a bath of molten solder. The solder covers all exposed metal surfaces. As the panel is removed from the solder, high pressure hot air is directed at both sides of the panel. The “blast” of air removes excess solder from the holes and smoothes the surface of the pads.

Rout, Fabrication, Score, Bevel

After HASL the boards are cut to size on a CNC machine or router. Most panels have the individual parts routed out into single pieces or arrays of varying sizes. Boards or arrays can also be scored so that they can be easily broken apart after assembly.

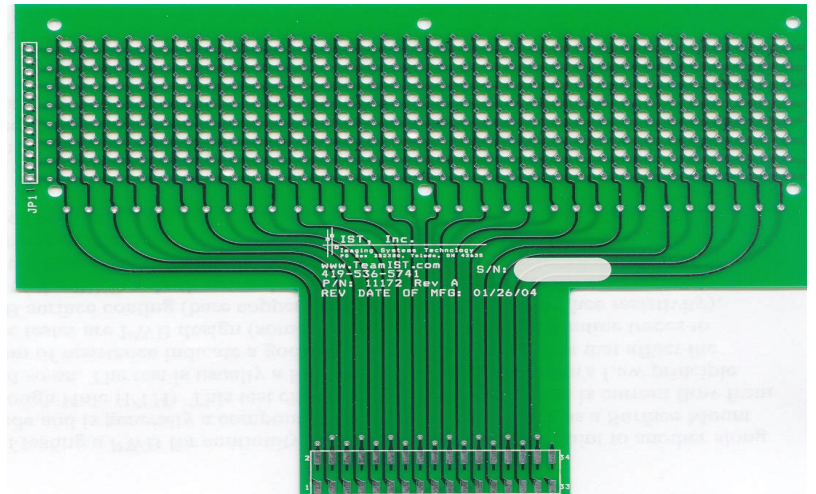
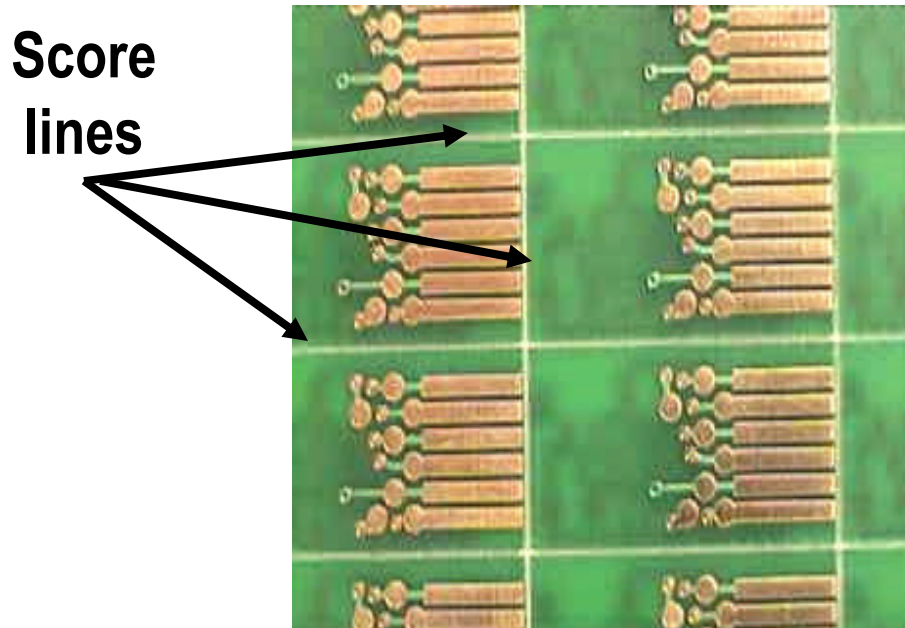

Then the boards are generally checked for cleanliness, sharp edges, burrs and other fabrication requirements. Chamfers, slots, countersinks and bevels are added during the rout & fabrication processes.

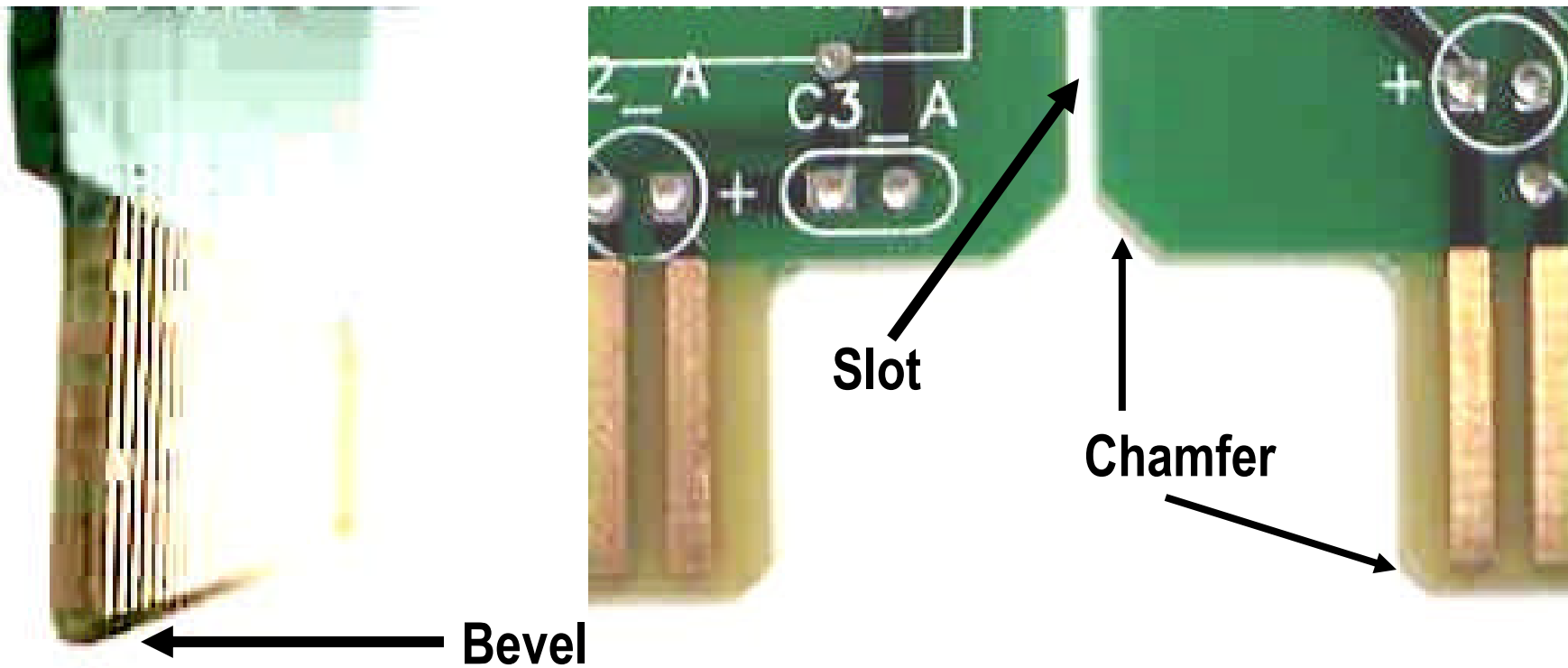

Bare Board Electrical Test

Boards are tested for opens and shorts in the circuitry, in one of the last steps of production. Test programs can be loaded directly onto various types of test machines or used to create specific fixtures and test programs.

Flying Probe test machine.

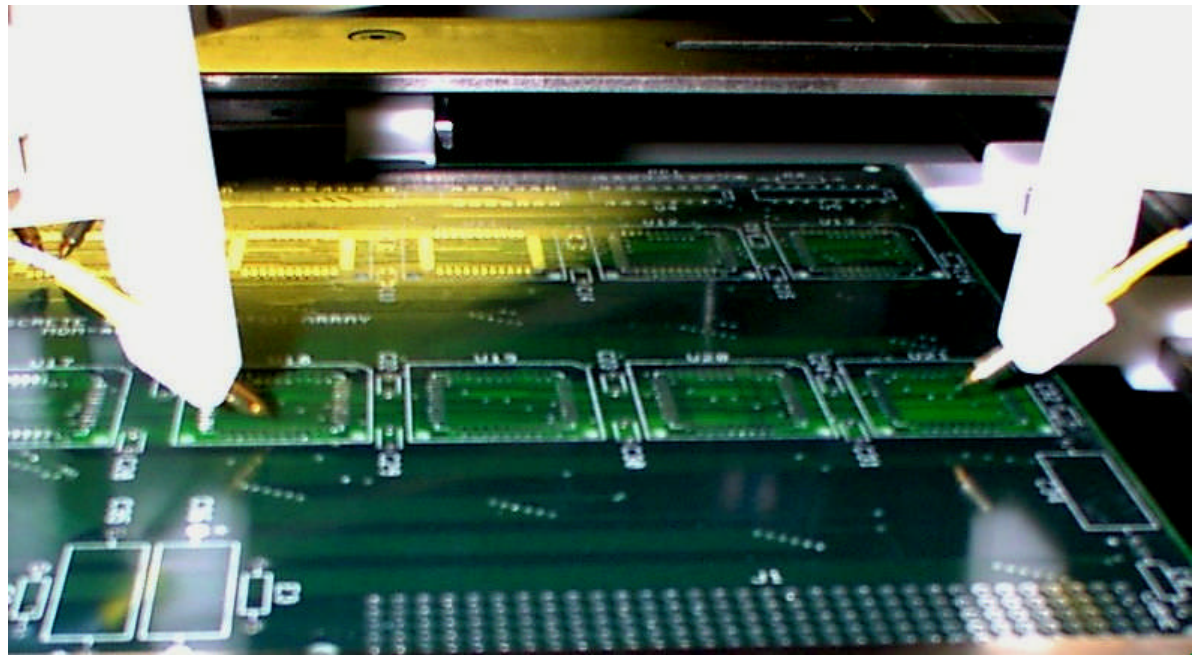

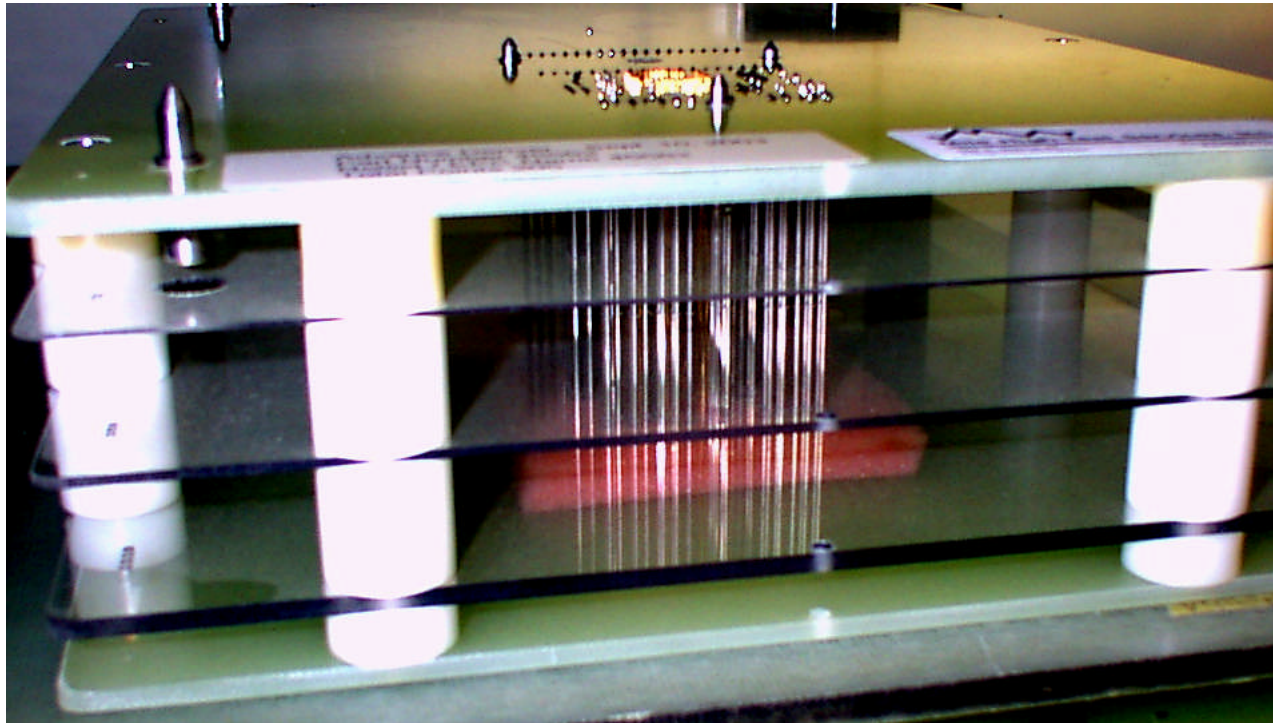

**Dedicated
fixture on a
universal grid
test machine.**

Shorts are repaired when possible and retested for verification. At Advanced Circuits we test 100% of the networks on the board for continuity and isolation (opens and shorts) using test programs generated from the Gerber data.

Final Inspection

Boards are visually inspected to assure they meet our customers' requirements, industry specifications and Advanced Circuits' standards, as well as having the physical dimensions and hole sizes verified.



Packaging and Ship

Circuit boards meeting the acceptability standards are counted, shrink wrapped and readied for shipment along with all the required certificates, samples, cross sections, etc. All of these are packaged for shipment using products made from renewable resource materials.

PLASTIC
WRAP



NET WT. 3.5 OZ. (99g)

With Other
Natural Flavors

**THIS SIDE
DOWN**

The End

This presentation is intended only as an introduction to the processes used in building a circuit board and as a training aid for employees, customers and friends of Advanced Circuits.

All of the artwork, photography and text is the property of Advanced Circuits Inc and may not be used without permission. Please Contact Tony Garramone, Corporate Training Manager at 1-800-979-4pcb x344 for information.